

ARCHITECT:

PROJECT:

DISTRIBUTOR:

SHEET:

DATE:

3-3/4" WALL - 1-1/2" TRIM

DOORMERICA
 ABS - Architectural Components
 8401 Rovana Cir. Sacramento CA. 95828
 Toll Free Number: (866) 566-2161
 Phone Main: (916) 388-2161
 Fax: (916) 388-9336

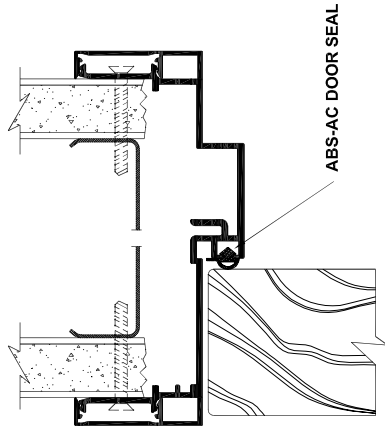

A

DOOR FRAME HEADER

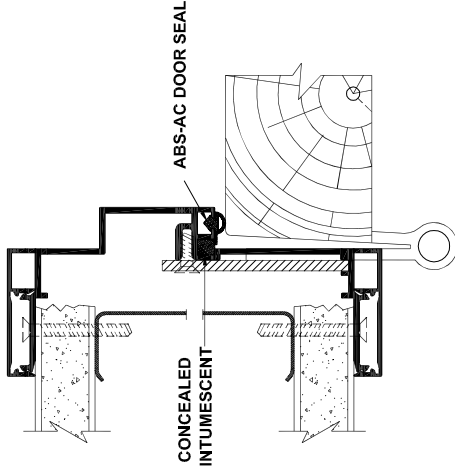

B

DOOR FRAME HINGE JAMB

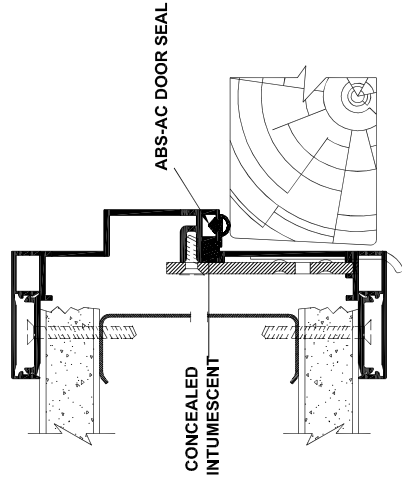

C

DOOR FRAME AT STRIKE JAMB
NOTE: EXTENDED LIP STRIKE NOT REQUIRED

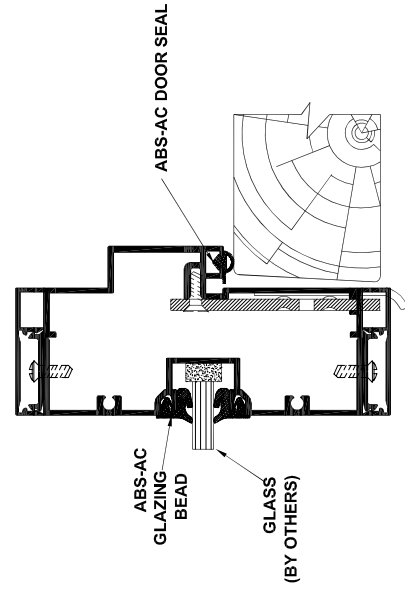

D

STRIKE JAMB & S.L. MULLION W/ 1-1/2" FACE
NOTE: EXTENDED LIP STRIKE NOT REQUIRED

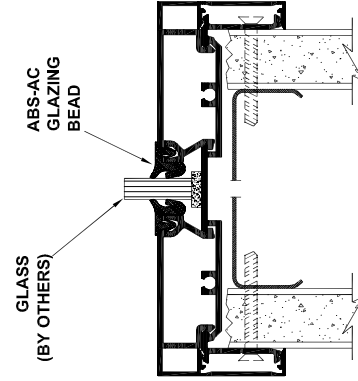

E

SILL BASE ON DRYWALL PARTITION

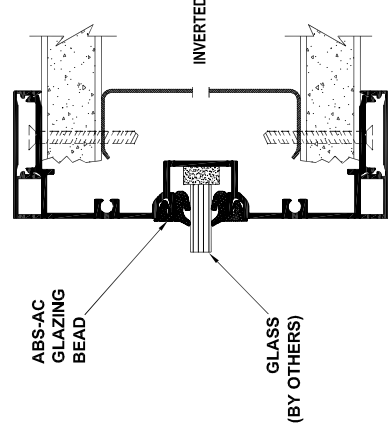

F

GLAZING RAIL

ARCHITECT:

PROJECT:

DISTRIBUTOR:

DATE:

SHEET:

3-3/4" WALL - 1-1/2" TRIM

DOORMERICA
ABS - Architectural Components
 8401 Rovana Cir. Sacramento CA, 95828
 Toll Free Number: (866) 566-2161
 Phone Main: (916) 388-2161
 Fax: (916) 388-9336

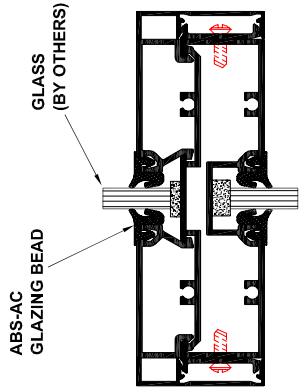

G

HORIZONTAL MULLION W/ 1-1/2" FACE

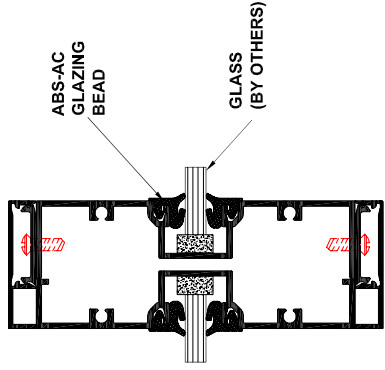

H

VERTICAL MULLION W/ 1-1/2" FACE

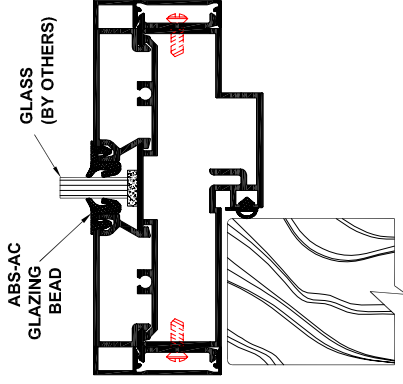

I

TRANSOM HEADER W/ 1-1/2" FACE

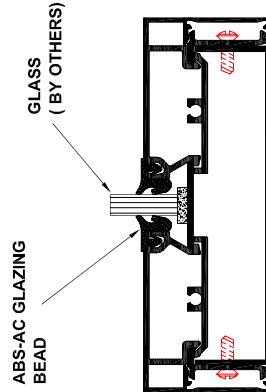

J

SILL BASE WITH RETAINER

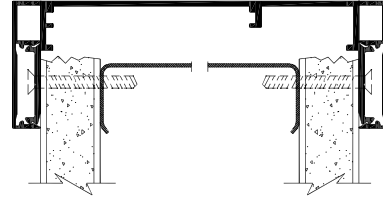

K

CASED OPENING